



THE DEVELOPER'S CONFERENCE

Arduino & Makers

ESP8266 101: baby steps

Ricardo Gomes da Silva

`rgsilva.com`

`@debugweshell`

Agenda



THE
DEVELOPER'S
CONFERENCE

- Introdução
- Arquitetura e Firmwares
- Exemplo
- Integração com Arduino
- Pontos de Partida
- Conclusão

Introdução



THE
DEVELOPER'S
CONFERENCE

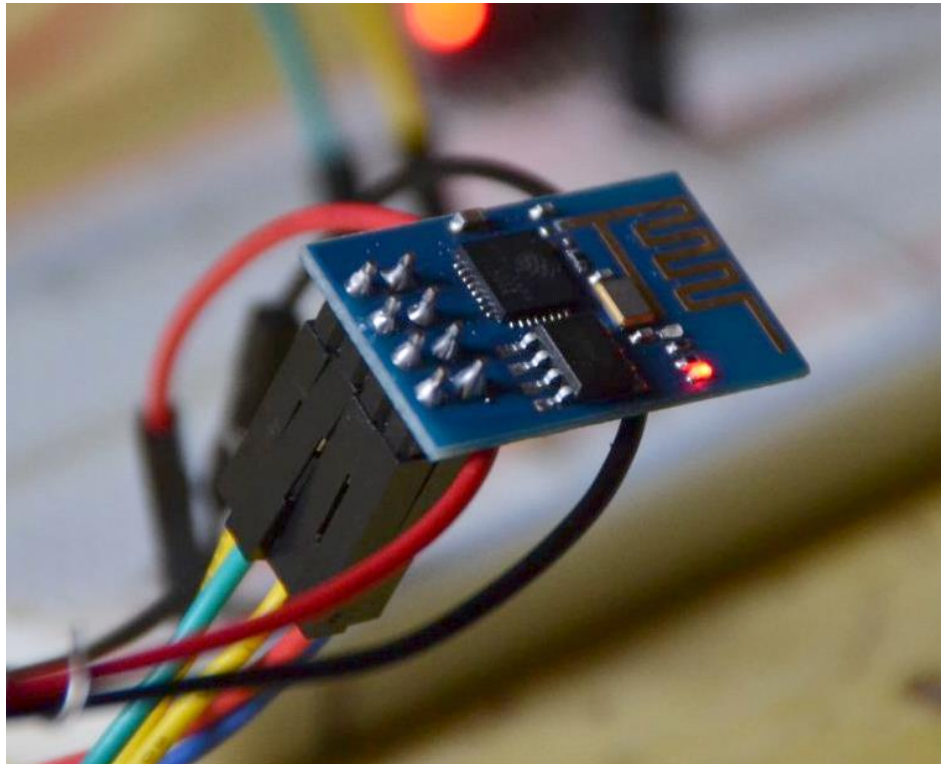

Introdução



THE
DEVELOPER'S
CONFERENCE

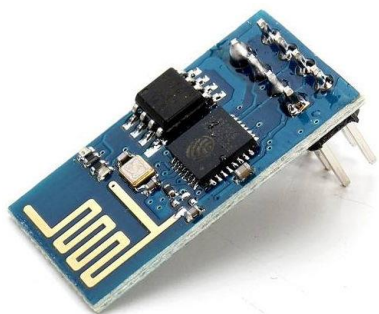

ESP-01



ESP-02

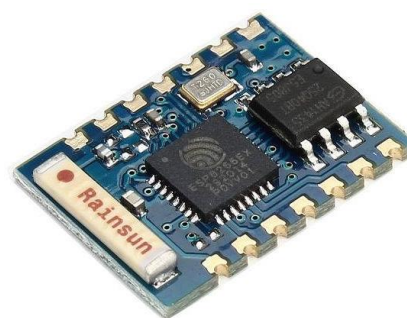

ESP-03

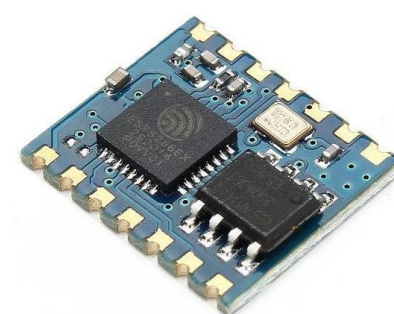

ESP-04

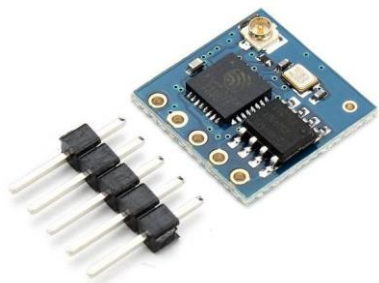

ESP-05



ESP-06



ESP-07



ESP-08

Arquitetura e Firmwares



THE
DEVELOPER'S
CONFERENCE

➤ Arquitetura

- RF 802.11 b/g/n
- CPU RISC 80MHz
- 64+96kB RAM

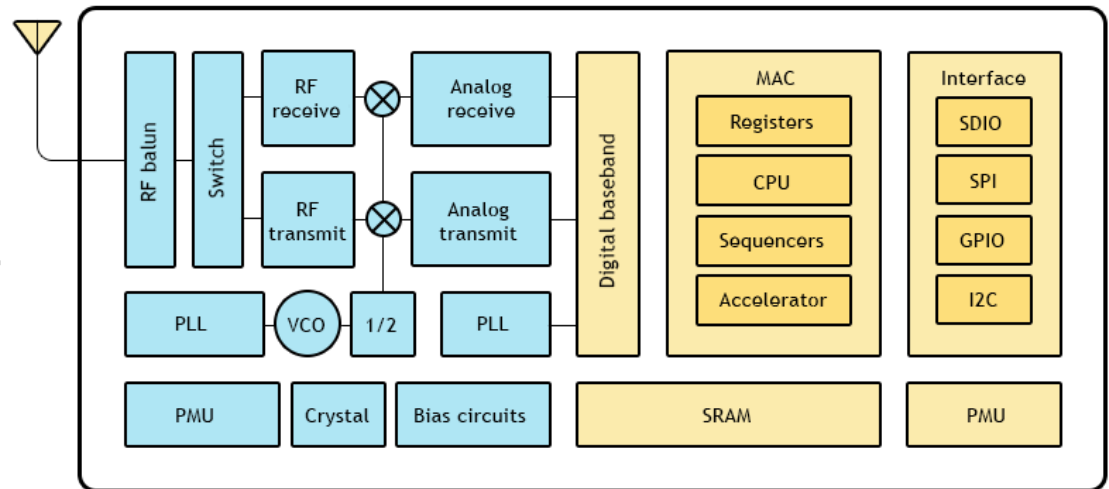

Fonte: ESP8266 datasheet

➤ Firmwares

- SDK
- Arduino IDE
- NodeMCU
- MicroPython

Exemplo



THE
DEVELOPER'S
CONFERENCE

```
-- Seta o modo estação.
```

```
> wifi.setmode(wifi.STATION)
```

```
-- Conecta na rede wifi.
```

```
> wifi.sta.config("Wow so much wireless", "dogethedoge")
```

```
-- Qual nosso IP?
```

```
> print(wifi.sta.getip())
```

```
172.16.1.155
```

```
255.255.0.0
```

```
172.16.1.1
```

Integração com Arduino



THE
DEVELOPER'S
CONFERENCE

- 3.3v vs 5v
 - Arduino
 - Regulador
- UART
 - Também 3.3v
 - Level shifter

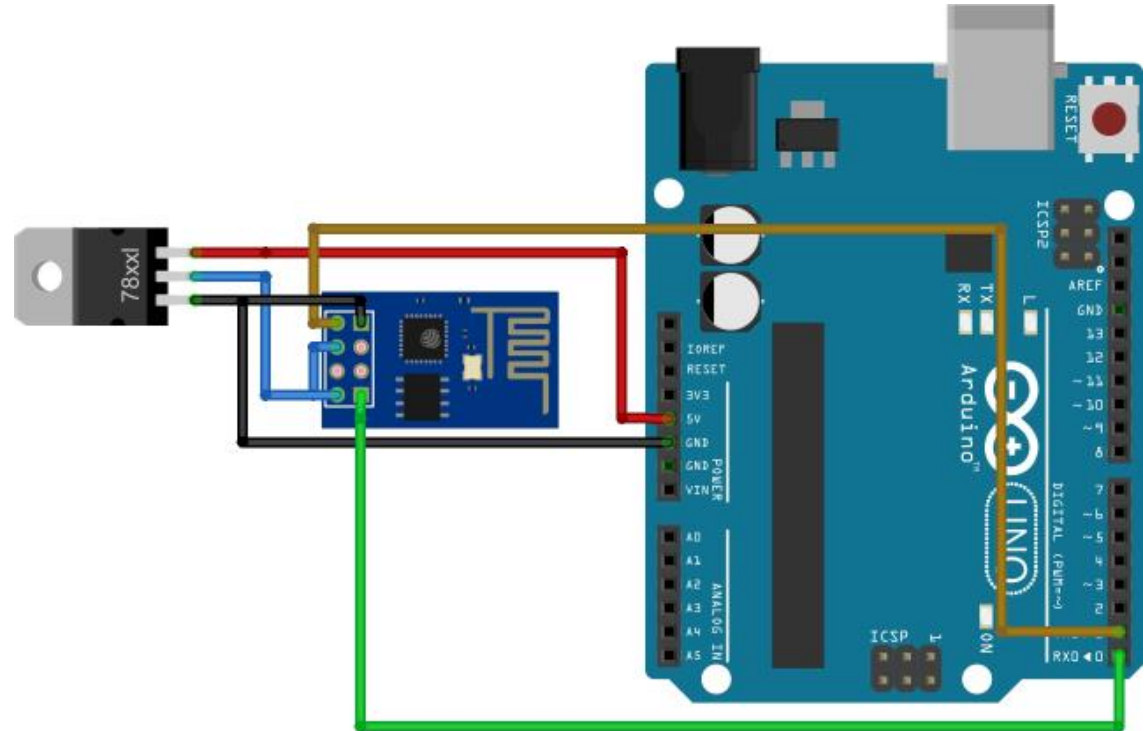

Fonte: www.whatimade.today

- Controle e comunicação via porta serial

Pontos de Partida



THE
DEVELOPER'S
CONFERENCE

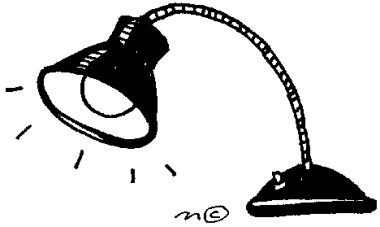
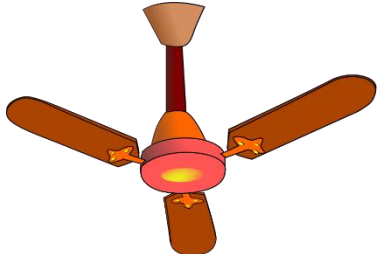
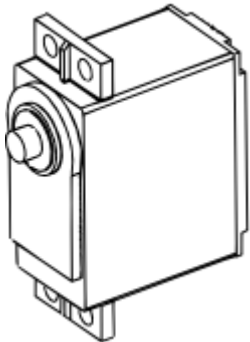
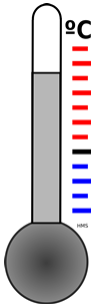
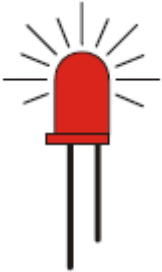

Conclusão



THE
DEVELOPER'S
CONFERENCE

➤ ESP8266

- Baixa complexidade
- Baixo custo
- Baixo consumo elétrico
- Longas distâncias

➤ Projetos

- Tudo sem fio?
- Integração
- Experiência



THE DEVELOPER'S CONFERENCE

Arduino & Makers

ESP8266 101: baby steps

Ricardo Gomes da Silva

`rgsilva.com`

`@debugweshell`